

Touring truss

Swing wing truss 30 x 30 spigoted

- › Swing wing truss 30 x 30 spigoted
- › Standard lengths:
 - 96" (3 bay, fits 3 moving heads)
 - 126" (4 bay, fits 4 moving heads)
- › Supports up to 3 lamp bars
- › Accessories include a 3rd caster assembly and cable hooks
- › Equipped with steel spigots
- › Main chords are 2" OD x 3/16" aluminum
- › Diagonals are 1-1/2" OD x 1/8" aluminum
- › Fabricated by AWS / SFL certified welders

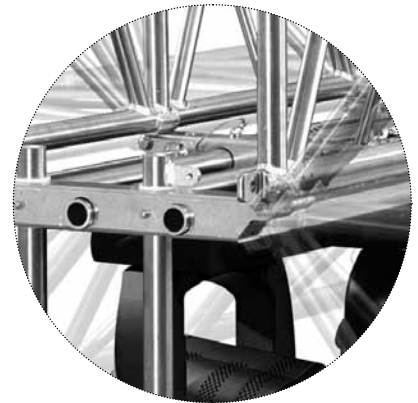

Plan Views – Connector Orientation Specified by Customer

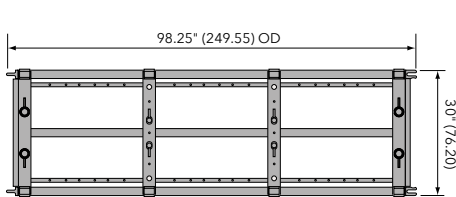

Plan

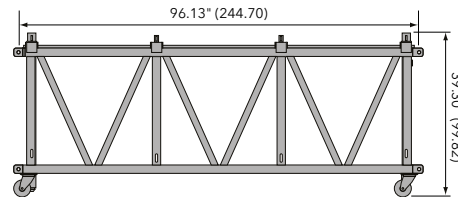

Elevation

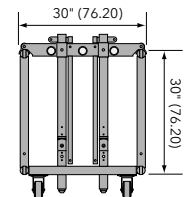

End View

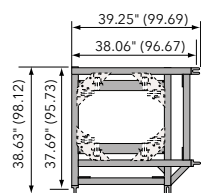

2-Way Corner Block

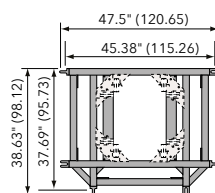

3-Way Corner Block

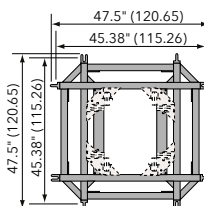

4-Way Corner Block

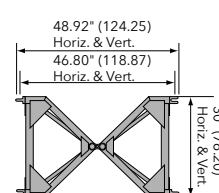

Center Pivot Horiz. Articulating Block

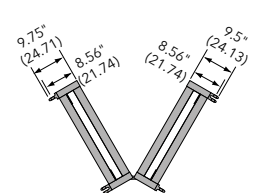

Horizontal Variable Corner

Loading chart

Span feet (meters)	Maximum allowable uniform loads			Maximum allowable point loads					
	Load lbs/ft	Load lbs (kgs)	Max Defl in.	center point		third point		quarter point	
				Load lbs (kgs)	Max Defl. in.	Load lbs (kgs)	Max Defl. in.	Load lbs (kgs)	Max Defl. in.
8 (2.43)	2180	17440 (7911)	0.03	10910 (4949)	0.03	6350 (2880)	0.01	4610 (2091)	0.02
16 (4.87)	1080	17280 (7838)	0.20	7490 (3398)	0.14	4690 (2127)	0.03	3570 (1619)	0.12
24 (7.31)	570	13680 (6205)	0.53	5610 (2545)	0.36	3650 (1656)	0.09	2870 (1302)	0.33
32 (9.75)	340	10880 (4935)	1.02	4400 (1996)	0.69	2940 (1334)	0.19	2360 (1071)	0.66
40 (12.19)	210	8400 (3810)	1.59	3550 (1610)	1.13	2420 (1098)	0.36	1970 (894)	1.12
48 (14.63)	140	6720 (3048)	2.32	2910 (1320)	1.69	2010 (912)	0.60	1650 (748)	1.71
56 (17.06)	100	5600 (2540)	3.16	2400 (1089)	2.33	1680 (762)	0.95	1390 (631)	2.44
64 (19.50)	70	4480 (2032)	4.15	1990 (903)	3.19	1400 (635)	1.43	1170 (531)	3.30

Spigots Only

Note: Deflections reported in the above tables are maximum expected for full loadings (indoor only). All loads are based on 96" (2.44 m) sections. Load tables are reprinted from engineering reports developed by Geiger, Gossen, Hamilton, Campbell Engineers, P.C. Structural Engineers.

Swing wing truss 30 x 30 spigoted Connections are steel spigots & 3/4" clevis pins

Product Description	Item Code	Weight lbs (kgs)
96" HDSW TRUSS (EMPTY)	TC 30SW-096S	240 (109)
126" HDSW TRUSS (EMPTY)	TC 30SW-126S	280 (127)
HDPRT 2-WAY CORNER BLOCK	TC 3030-C2S	109 (50)
HDPRT 3-WAY CORNER BLOCK	TC 3030-C3S	134 (61)
HDPRT 4-WAY CORNER BLOCK	TC 3030-C4S	160 (73)
3/4" CLEVIS PIN	TC CP-75	0.4 (0.18)
MEDIUM R-CLIP	TC RC-MED	- (-)